

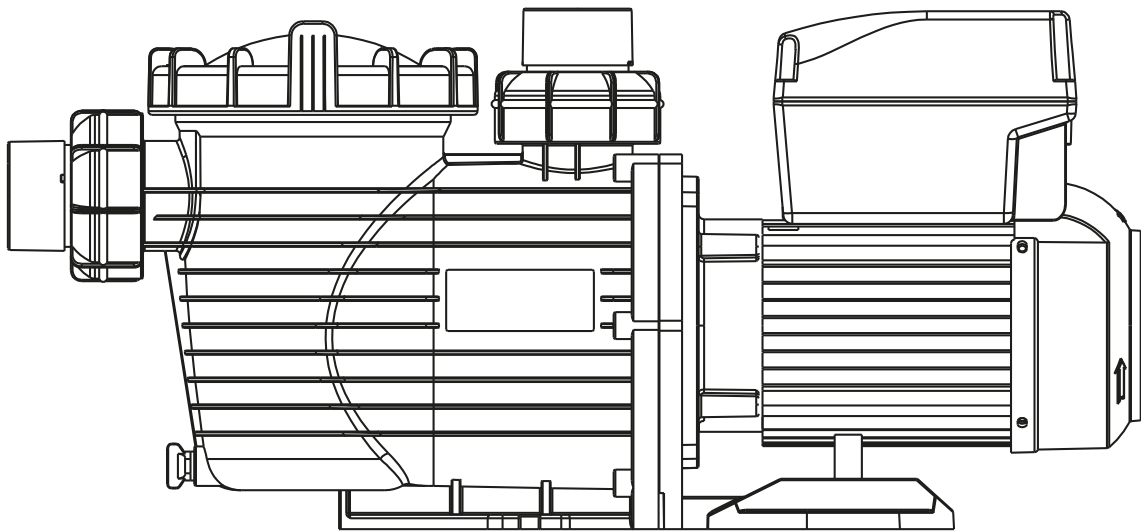

# NPVS150 Pump Installation & Operating Instructions



Scan for online user manual

# TABLE OF CONTENTS

Pump Installation.....	3
User's Guide.....	4-5
Menu Structure.....	6-7
Programming.....	8
Fault Treatment.....	9
Operating Procedure.....	9-13
Wi-Fi Settings.....	13-16
Routine Maintenance.....	16
Service & Repair Parts.....	16
Trouble Shooting.....	17
Replacement Parts.....	18
Overall Dimensions.....	19
Product Information.....	19

**▲ WARNING:** The pump must be installed in accordance with AS3000 Wiring Standards and AS/NZS 2032:2006 Standards Installation of PVC Pipe Systems. Only qualified, licensed or accredited personnel should install pump.

**▲ WARNING:** This appliance is not intended for use by persons (including children) with reduced physical, sensory or mental capabilities, or lack of experience and knowledge, unless they have been given supervision or instruction concerning use of the appliance by a person responsible for their safety.

**▲ WARNING: DO NOT START PUMP DRY.** Running the pump dry for any length of time will cause severe damage and will void the warranty.

## **▲ CAUTION**

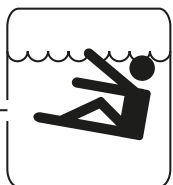

**Hazardous suction. Can trap hair or body parts, causing severe injury or death. Do not block suction.**

## PUMP LOCATION:

Pool Pro recommends the pump:

- Be located as close to pool as possible.
- Be installed at no more than 1 metre above water level.
- Have gate valves installed if the pump is located below water level.
- Allow pump suction inlet height to be as close to water level as possible.
- Have a check valve installed on the suction line of the pump.
- Allow use of short, direct suction pipe (To reduce friction loss).
- Be installed in a manner that allows adequate access for servicing of the pump and any relative piping.
- Be away from direct sunlight.
- Be located in a dry area with adequate drainage.
- Be on solid, level, rigid and vibration free surface.

## INSTALLATION RECOMMENDATIONS:

1. Connect the suction and discharge pipe to the inlet and outlet of the swimming pool. **NOTICE: Pump suction and discharge connections have molded pipe stops, DO NOT try to push pipe in beyond these stops.**
2. The piping must be well supported and not forced together where it will experience constant stress.
3. Use the fewest amount of fittings possible. Each additional fitting has the effect of moving the equipment farther away from the water.
4. The pump is to be supplied through a residual current device (RCD) having a rated residual operating current not exceeding 30mA.

### Correct Disposal of this product:

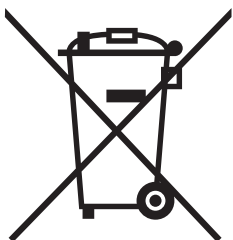

This marking indicates that this product should not be disposed with other household wastes. To prevent possible harm to the environment or human health from uncontrolled waste disposal, recycle it responsibly to promote the sustainable re-use of material resources.

# 1. Pump Operation

## 1.1 Operation

The pump is fitted with a wide range of settings to suit most filtration requirements. The controller is used to program a range of motor speeds and settings described as "Schedules" in the program. To program the pump go to page 5 for an easy description on how this is done. **NEVER run pump dry! Running pump dry will damage seals, causing leakage! Prime pump with water before starting, or after emptying basket.**

## 1.2 Priming Pump:

- Ensure pump is turned off.
- Release all air from filter and piping system: see filter owner manual.
- If in a flooded suction system (water source higher than pump), open suction and discharge valves then release all air pressure.
- If not in a flooded suction system, unscrew and remove pump lid and fill wet end with water.
- Reinstall pump lid, ensuring the O-Ring is located correctly, free of debris and lubricated with silicone grease.

**NOTICE: Only tighten pump lid by hand.**

- Turn on pump.
- Release any air pressure from system: see filter owner manual.

**NOTICE: If the pump fails to prime with continuous water flow within 30 seconds, repeat above process.**

**NOTICE: Failure to prime correctly may cause premature wear on components and will void warranty.**

# 2. User' s Guide

## 2.1 Overview

This controller is matched with the variable speed drive for the variable speed pump. Functions as shown below:

- 1) Timer: Built in real time clock.
- 2) Control Parameters: Power usage and motor running speed (RPM) display.
- 3) Preset Running Speed: 3 preset running speeds.
- 4) Parameter Setting: Real time clock, 3 preset running speeds, 3 schedule settings, self priming setting.
- 5) Error Display: Over Current, Over Voltage, Under Voltage, Overheating fault code.
- 6) Auto Recovery: Over Current, Over Voltage, Overheating, Power Failure, restore to the settings before the error.
- 7) Power Failure Recovery: When power resumes from failure, will restore to the settings before the power failure.

## 2.2 Controller Outlook Display

### 2.2.1 Interface Display Diagram

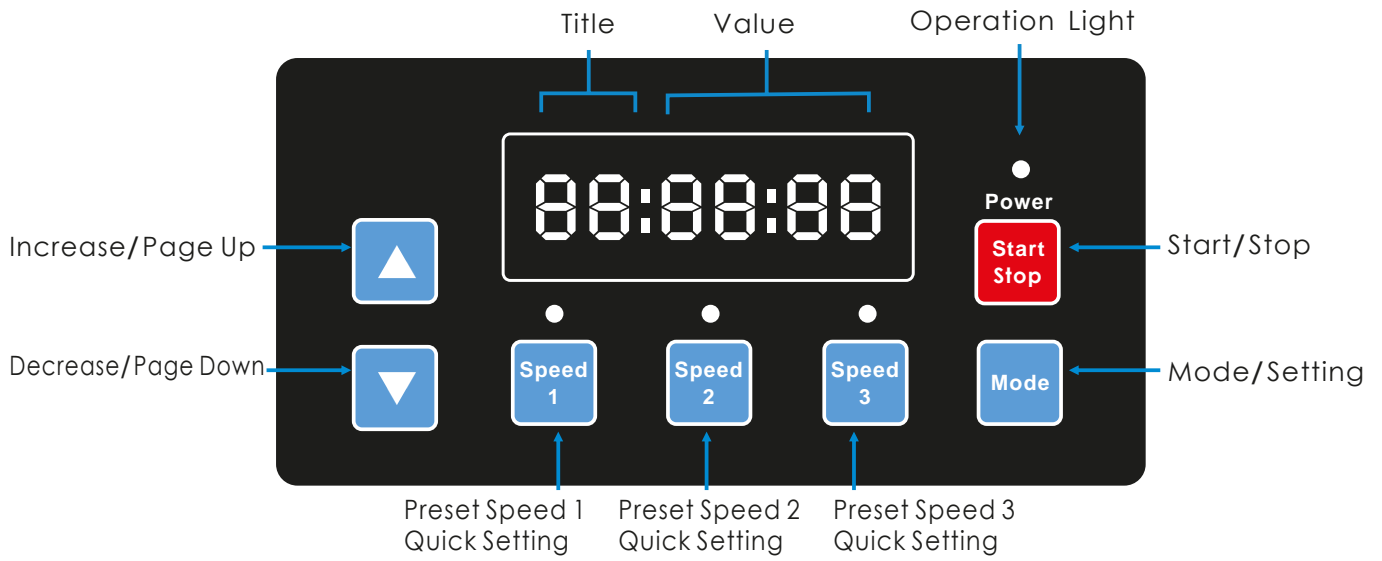

### 2.2.2 Indication Light Reference

	S1	S2	S3	Running Light	Operation Light Flashing
Preset Speed 1 Enable	1	0	0	X	0
Preset Speed 2 Enable	0	1	0	X	0
Preset Speed 3 Enable	0	0	1	X	0
In Operation	X	X	X	1	0
Warning	1	1	1	1	1

Remark: "1" Light On, "0" Light Off, "X" N/A

(Chart 2.1)

### 3. Menu Structure

#### 3.1 Program Flow Chart

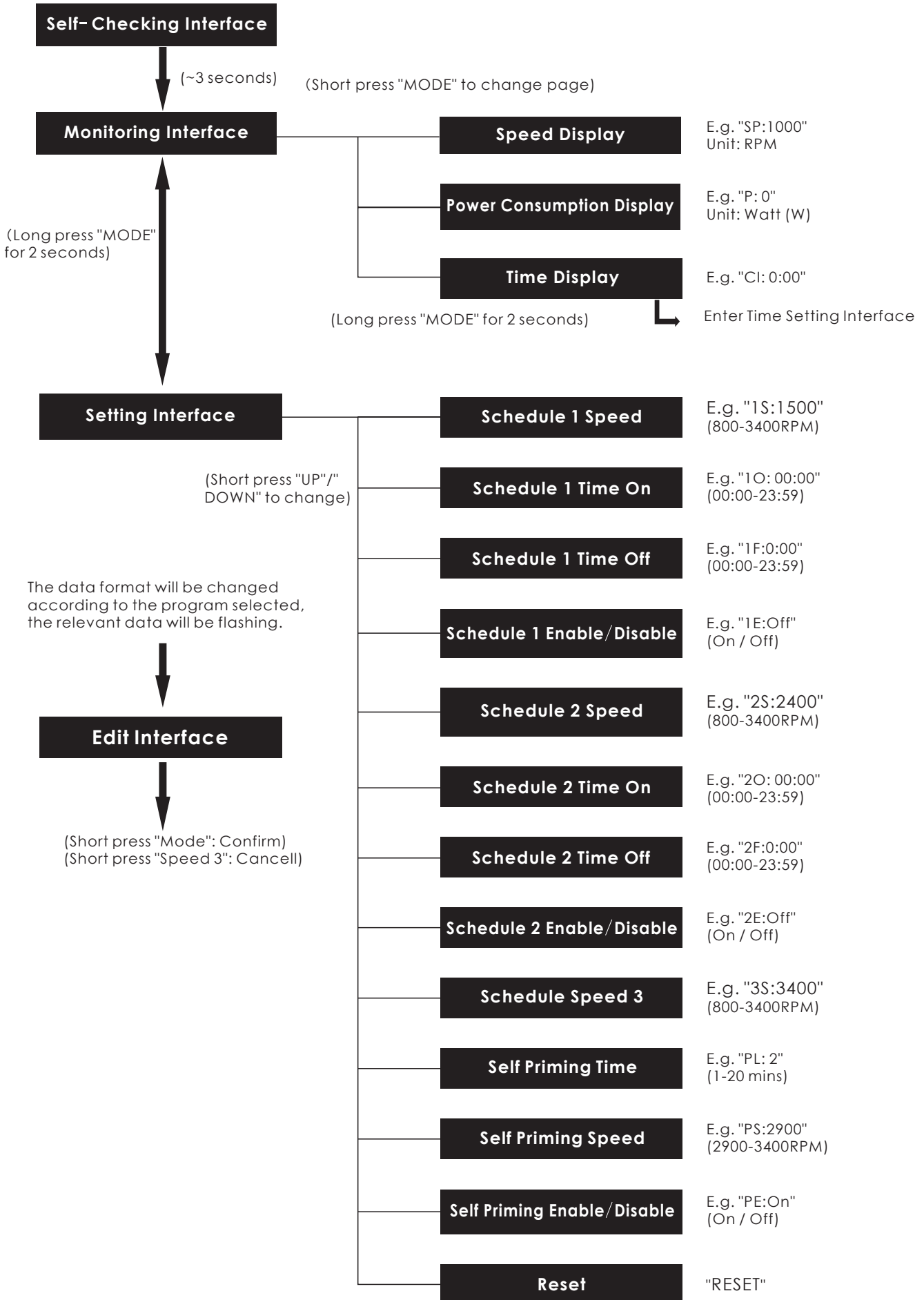

### 3.2 Buttons Control

Action	Monitoring Interface	Setting Interface	Edit Interface	Error/Auto Recovery
Short press "UP"	Current speed +10rpm	Page Up	Add current value	N/A
Long press "UP"	Current speed increase rapidly	Page Up rapidly	Add current value rapidly	N/A
Short press "DOWN"	Current speed -10rpm	Page Down	Reduce current value	N/A
Long press "DOWN"	Current speed decrease rapidly	Page Down rapidly	Reduce current value rapidly	N/A
Short press "MODE"	Change page	Enter Edit Interface	Confirm change, back	N/A
Long press "MODE"	When in the Time Display page: Enter Time Setting When in other pages: Enter Setting Interface	Enter Monitoring Interface	N/A	N/A
Short press "Start/Stop"	Start / Stop	Start / Stop	N/A	Auto Recovery
Long press "Start/Stop"	N/A	N/A	N/A	N/A
Short press "Speed 1"	Set current speed to preset speed 1	Switch to preset speed 1	Edit cursor move left	N/A
Long press "Speed 1"	N/A	N/A	Edit cursor move left rapidly	N/A
Short press "Speed 2"	Set current speed to preset speed 2	Switch to preset speed 2	Edit cursor move right	N/A
Long press "Speed 2"	N/A	N/A	Edit cursor move right rapidly	N/A
Short press "Speed 3"	Set current speed to preset speed 3	Switch to preset speed 3	Cancel change, back	N/A
Long press "Speed 3"	N/A	N/A	N/A	N/A

(Chart 3.1)

## 4. Programming

### 4.1 Programmed Schedule

- 1) Two schedule settings are available, preset speed at 1500RPM, 2400RPM.
- 2) Each schedule setting has 4 parameters "Running Speed", "Time On", "Time Off", "Enable/Disable".
- 3) Programmed Schedule Priority: Schedule 1 > Schedule 2 .
- 4) Programmed Schedule Logic: If more than 1 schedule is enabled within the same time period, the controller will operate only with the highest priority schedule and speed, the corresponding indication light will on.
- 5) Programmed Schedule Termination: If all schedules are completed with its setting time, the controller will switch back to the condition before the schedule.
- 6) Programmed Schedule Manually Disable: When any programmed schedule is running, press any button ("UP", "DOWN", "Start/Stop", "Speed 1", "Speed 2", "Speed 3") in the monitoring interface with disable all programmed schedules. (Pressing "Start/Stop" will stop the pump, the last running speed will be recorded, the operation light will remain; Press "UP", or "DOWN", running speed add/reduce 10rpm from the current speed, the operation light will off; Press "Speed X", the selected speed will replace the current speed, with the corresponding speed indication light on)
- 7) The scheduled settings and auto recovery will not contradict each other. When there is error, the variable speed driver will restore to the settings before the error. (The priority setting is still applicable)

### 4.2 Self Priming

- 1) Self Priming setting has 3 parameters "Self Priming Time", "Self Priming Speed", "Enable/Disable".
- 2) Self Priming function will be activated if the function is enabled, the running speed is lower than the "Self Priming Speed" and the running time is less than the "Self Priming Time".
- 3) Self Priming default as "Enable".

### 4.3 Auto Recovery

- 1) Auto Recovery is a core function, with no setting options.
- 2) When there is Over Current, Over Voltage or Low Voltage error, the variable speed driver will recover automatically and will restart after 10 seconds.
- 3) In the first 5 seconds, the display will shows the "error details /error times" (e.g. "OC1 1T"). In the next 5 seconds, the display will shows the "Count down details / Count down time" (e.g. "AR 5" or "AS 5")
- 4) If two errors happen in less than 60 seconds intervals, the auto recovery time will increase once. If the auto recovery increase to 3 times, the system will direct to the Error menu, and will not auto recover.
- 5) Press "Start/Stop" button to cancel the count down during the auto recovery process, to activate the auto recovery immediately.

### 4.4 Power Failure Recovery

- 1) The current settings (Enable/disable, current speed, scheduled settings) are protected by the capacitance, the memory will be kept for 72 hours.
- 2) When the power is reconnected, the variable speed driver will restore to the settings before the error.

### 4.5 Real Time Clock

- 1) Real time clock display time in "hours:minutes"
- 2) Long press "MODE" button at the "Time Display Page" to enter "Time Setting".

### 4.6 Reset

At the setting interface, switch to the Reset menu, display "RESET", short press "Mode", the content of the screen will flash, short press "Mode" again, reset complete. Short press "Speed 3" while the content is flashing to stop the reset.



## 5. Fault treatment

### 5.1 Communication error

When there is a communication error between the controller and the variable speed driver, an error code "ER...." will be displayed.

### 5.2 Error Display

When the Controller is not working, a fault code will be shown on the controller display, E.g. "ER: OV".

Press "Start/Stop" button will restore the controller.

Below the common fault code list:

Error	Description	Reason
OC	Over Current: Driver's output current exceeds the threshold (200% of rated current)	<ul style="list-style-type: none"> <li>Driver output failure</li> <li>Driver IPM module is damaged</li> </ul>
OV	Over Voltage: Main circuit DC voltage exceeds the threshold	<ul style="list-style-type: none"> <li>Over power of the power supply</li> <li>Power supply voltage exceeds controller setting</li> </ul>
UV	The main electric current is too lowUnder Voltage:	<ul style="list-style-type: none"> <li>Power supply disconnected, driver discharging</li> <li>Supply voltage fluctuation it too large</li> </ul>
OH	Motor heat sink overheatingOver Heat:	<ul style="list-style-type: none"> <li>Ambient temperature is too high</li> <li>Motor Cooling Fan does not work</li> </ul>

(Chart 5.1)

## 6. Operating Procedure

### 6.1 Starting

After starting, the driver will run the self-checking procedure by scanning the display and the operation light, as diagram 6.1.

When there is communication error between controller and the variable speed driver, communication error will be displayed, as diagram 6.2.

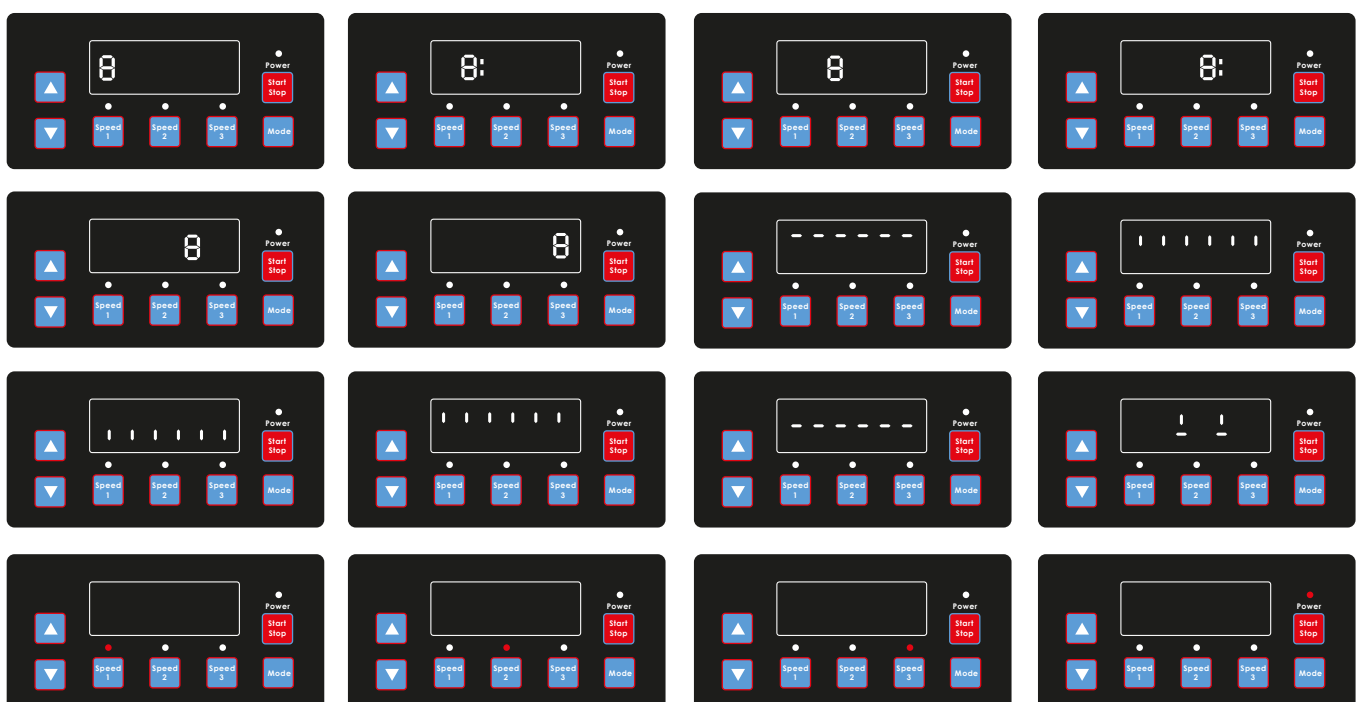

(Diagram 6.1, Self-checking procedure)

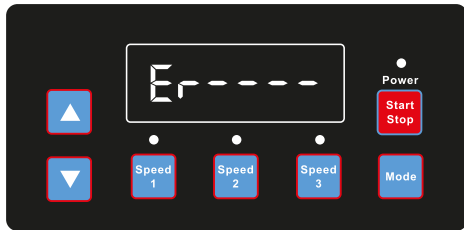

(Diagram 6.2, Communication Error)

## 6.2 Monitoring Interface

After starting, enter "Monitoring Interface". As diagram 6.3.

Short press "Mode" to interchange between speed or time display page. As diagram 6.3-6.5.

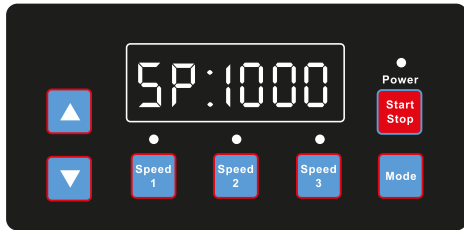

(Diagram 6.3, Speed display page)

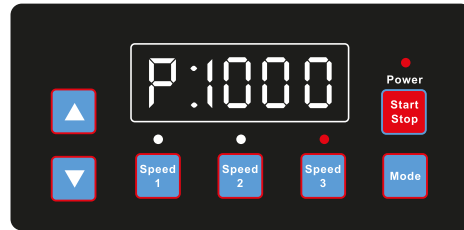

(Diagram 6.4, Power consumption display page)

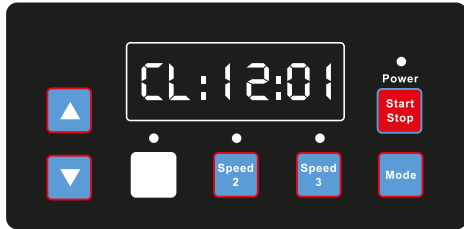

(Diagram 6.5, Time display page)

Short press "Speed1" to "Speed3", to switch to the 3 preset speeds, the corresponding indication light will on, as diagram 6.6-6.8.

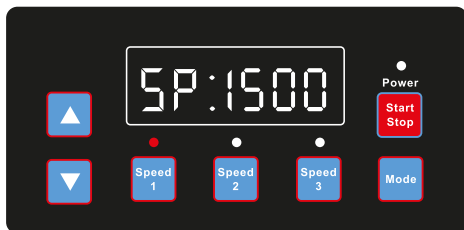

(Diagram 6.6, Speed 1)

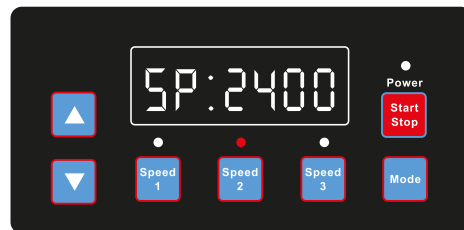

(Diagram 6.7, Speed 2)

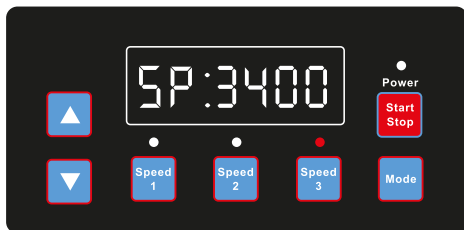

(Diagram 6.8, Speed 3)

At any time press "Run", to stop/start the variable speed driver, and light on/off the operation light.

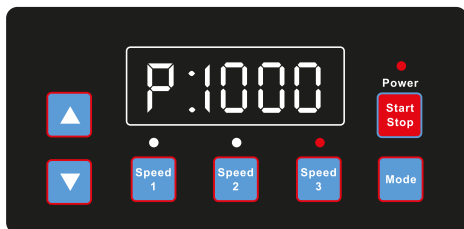

(Diagram 6.9, Power consumption display, Speed 3)

At any time press "Up" or "Down", to add or reduce the rpm by 10, as diagram 6.10-6.11.

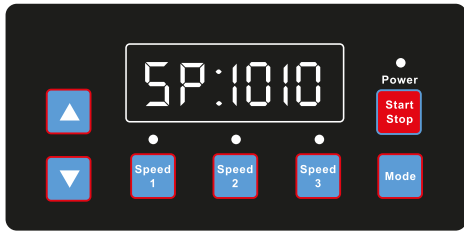

(Diagram 6.10, 1000rpm press "Up" once)

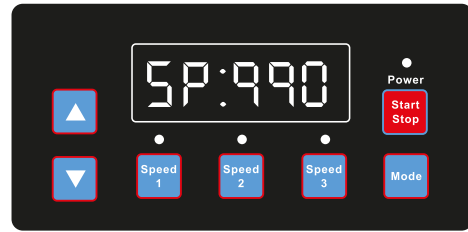

(Diagram 6.11, 1000rpm press "Down" once)

Long press "Mode", to enter the setting interface, as diagram 6.12.

### 6.3 Setting Interface

Short press "Mode" to interchange between "Schedule 1 Speed", "Schedule 1 Time On", "Schedule 1 Time Off", "Schedule 1 Enable/Disable", "Schedule 2 Speed", "Schedule 2 Time On", "Schedule 2 Time Off", "Schedule 2 Enable/Disable", "Schedule 3 Speed", "Self Priming Time", "Self Priming Speed", "Self Priming Enable/Disable", "Auto Recovery" pages. As diagram 6.12-6.23.

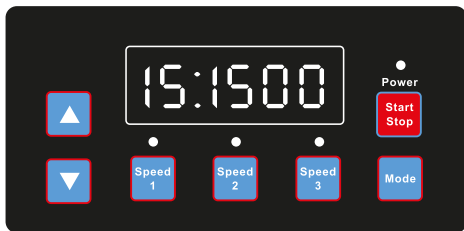

(Diagram 6.12, Schedule 1 Speed, default 1500rpm)

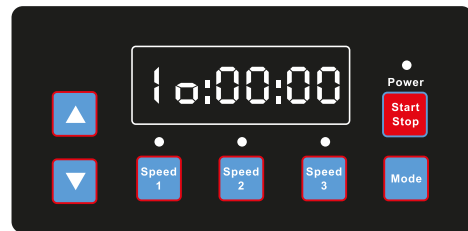

(Diagram 6.13, Schedule 1 Time On, default 00:00)

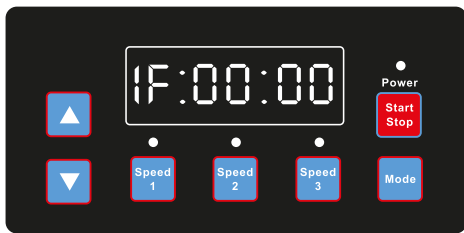

(Diagram 6.14, Schedule 1 Time Off, default 00:00)

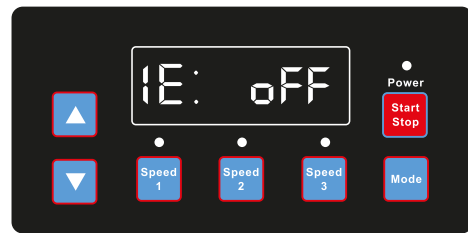

(Diagram 6.15, Schedule 1 Enable/Disable, default Off)

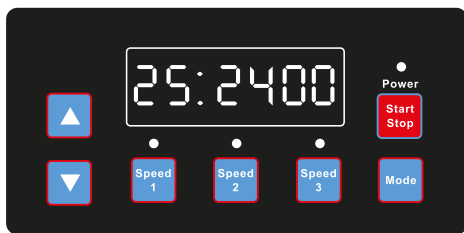

(Diagram 6.16, Schedule 2 Speed, default 2400rpm)

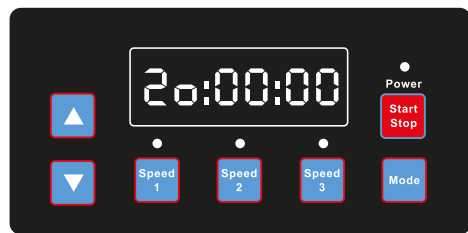

(Diagram 6.17, Schedule 2 Time On, default 00:00)

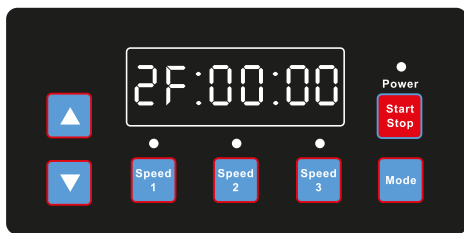

(Diagram 6.18, Schedule 2 Time Off, default 00:00)

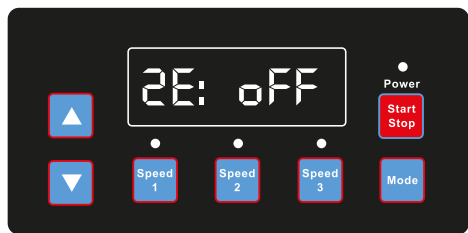

(Diagram 6.19, Schedule 2 Enable/Disable, default Off)

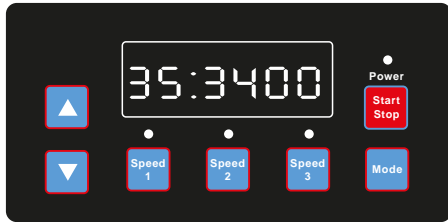

(Diagram 6.20, Schedule 3 Speed, default 3400rpm)

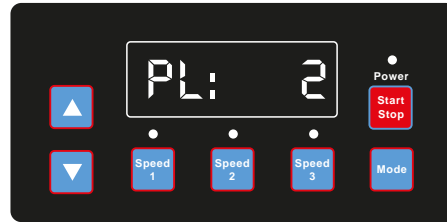

(Diagram 6.21, Self Priming Time, default 2 mins)

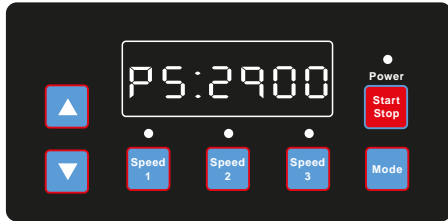

(Diagram 6.22, Self Priming Speed, default 2900rpm)

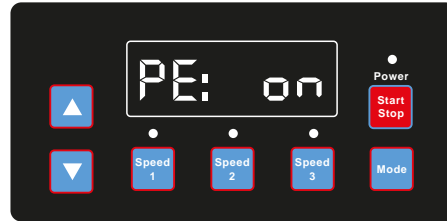

(Diagram 6.23, Self Priming Enable/Disable, default On)

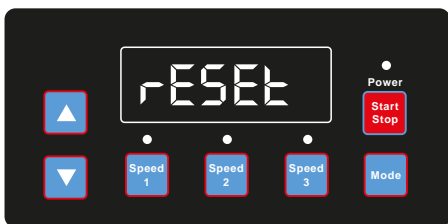

(Diagram 6.24, Reset)

Short press "Speed 1", "Speed 2", "Speed 3" to switch to "Schedule 1 Speed", "Schedule 2 Speed" or "Schedule 3 Speed".

#### 6.4 Edit Interface

Long press "Mode" at the time display page under monitoring interface or short press "Mode" at any display page to enter the edit interface.

At the edit interface, the changeable area will flash, press "Up" or "Down" to change the value, press "Speed 1" or "Speed 2" to move left or right.

When editing, short press "Mode" to confirm, or short press "Speed 3" to cancel.

#### 6.5 Auto Recovery

When there is "OC", "OV", "OL", "OH", "UV" error, the system will recovery automatically. If two errors happened in less than 60 seconds interval, the "Auto Recovery" time will increase once. If the auto recovery increase to 3 times, the system will direct to the Error menu, and will not auto recover.

The "Auto Recovery" page will display the error details (diagram 6.25) in the first 5 seconds and the count down details in the next 5 seconds (diagram 6.26)

Press "Start/Stop" button to cancel the count down during the auto recovery process, to activate the auto recovery immediately (without activating the auto run).

If there is error and the variable speed driver is in operation, then after auto recovery the system will enter the auto start page. The auto start page will display the error details (same as auto recovery, last for 5 seconds) and count down details (diagram 6.27, last for 5 seconds). At any time, short press "Run" to cancel the procedures and auto recover immediately (the variable speed driver will default Off).

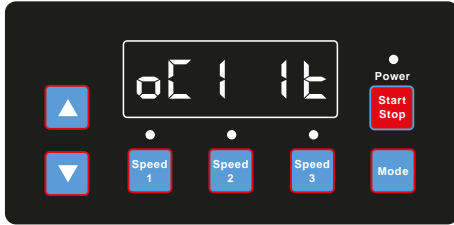

(Diagram 6.25, Auto Recovery, error details OC1, error time 1)

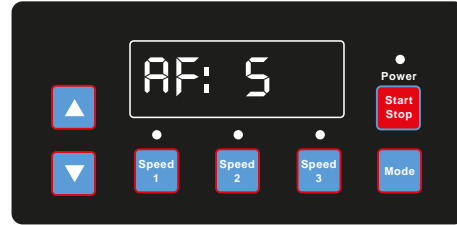

(Diagram 6.26, Auto Recovery count down, 5 seconds remaining)

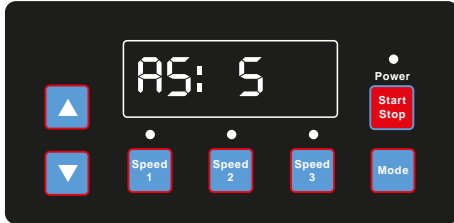

(Diagram 6.27, Auto Start count down, 5 seconds remaining)

## 6.6 Error Menu

Error Menu display as diagram 6.28, error details will be displayed and all lights will be flashing. Short press "Run" at the error menu, to auto recover the variable speed driver (keep the driver Off).

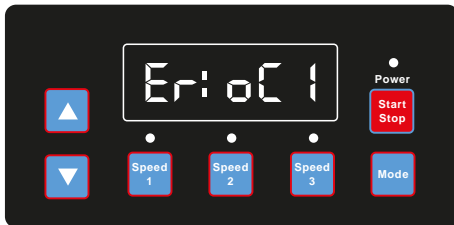

(Diagram 6.8 Error, Error code OC1)

## 7. Wi-Fi Settings

The NPVS Series pump contains a control interface with built in Wi-Fi to control the pump over Wi-Fi in Wi-Fi Direct ONE to ONE and Home Network situations.

### ENABLE WI-FI CONNECTION

1. Connect to AC power and Power on NPVS variable speed pump by "Run" button after proper piping installation.
2. The pump will start self-pumping and Wi-Fi icon should display next to the clock in a few minutes.
3. If there is no Wi-Fi icon displayed, press the "MENU" button and scroll down to item 10 by "▼", press "ENTER" to access Wi-Fi setting.
4. Press "FUNCTION" to display the selection.
5. Press "Enabled" by pressing "ENTER" and "ESC" to go back to home display.

### Wi-Fi Direct CONNECTION

NPVS Wi-Fi Direct connection is a ONE to ONE connection without accessing a Home Network. It is just like a private controller. It can be connected and controlled by mobile phone, tablet, PC, laptop or any Wi-Fi enabled devices directly without computer operation system concerns. The user interface supports most of the popular web browsers.



Wi-Fi Direct



1. Go to Wi-Fi setting of mobile phone and find "EPV SPV-WiFi" and enter password "VS\_PUMP" for connection. This is the factory default SSID name and password.
2. Scan the QR code label on the side of the controller unit on the pump, it will access the user interface and the browser will show "EPVPUMP.com" which is a virtual domain name without internet connection.
3. Or, by typing IP address 192.168.8.1 in your web browser to access.

## APPLICATION INTERFACE

The user interface can do all the NPVS settings and programming as the control panel on the pump, along with status display.

1. Touch the "Run/Stop" button to switch the pump ON/OFF.
2. Touch the speed "number, 2500", enter the speed and touch any location of the screen for enter. The pump will run at new speed.
3. Press S1-S4 to select the pre-program speed.
4. Pump running status, schedule status and error code displays at the bottom.
5. Touch the SETTING icon to enter Settings page.
6. Touch "English" at the top of the screen to select language. The control page support languages in English, French, German, Italian, Spanish, Russian and Chinese.

Language pull down selection    Wi-Fi Valid connection display    Setting page link

English

**VARIABLE SPEED PUMP**

Power rate display    914W | 130 GPM    Flow Rate display

Speed Input  
Touch the screen for update

SPEED 2500 RPM

Pump Run / Stop button

speed 1~4 selection button

S1    S2    S3    S4

PUMP STATUS		
Schedule 1	10:30-11:30	1200 rpm
Schedule 2	14:30-17:30	2900 rpm
Schedule 3	19:30-21:30	1150 rpm
Schedule 4	0:0-0:0	1150 rpm

Enabled Schedule display

Status display  
- Priming  
- SRVS  
- Freeze protection  
- Fault message  
- ...

Page 1

Time of your Wi-Fi Device    Press to write time to EPV

192.168.8.1/setting.html

local time 9:08

Sync

Re-nameable Speed 1-4

Speed	Value
S1	1900
S2	2350
S3	1650
S4	2500

Slide or type to set Speed 1-4

Re-nameable Schedule 1-4

Schedule	TIME ON	TIME OFF	SPEED	Enable / Disable switch
Schedule 1	10:30	11:30	SPEED2	<input type="checkbox"/>
Schedule 2	14:30	17:30	SPEED4	<input type="checkbox"/>
Schedule 3	19:30	21:30	SPEED1	<input type="checkbox"/>
Schedule 4	0:0	0:0	SPEED1	<input type="checkbox"/>

Enable / Disable switch

FREEZE PROTECTION SETTING

Time On 4 hrs    1800    Enable / Disable switch

Running time 4/8 hrs selection    Slide or type to set Speed

BACK    SAVE

Go to page 1    SAVE button for any change update

Page 2

1. Touch the "SYNC" to set the pump clock, the pump will follow the clock of your Wi-Fi device.
2. Speed 1-4 speed setting is done by slider or direct enter into the speed box.
3. Speed 1-4 can be renamed as you prefer in less than 10 characters.
4. Schedule 1-4 can set Time ON and OFF duration and among Speed 1-4. Schedule can be renamed as you prefer in less than 10 characters. There is enable and disable switch at the end of each setting to turn it ON or OFF.
5. Freeze protection default temperature is 4°C in 4 or 8 hours running in setting speed.
6. To do any change, touch save to store the change before going back to the home page.

## CHANGE SSID AND PASSWORD

The SSID and Password can be changed by typing the IP address 192.168.8.1:88 to access the Wi-Fi Network setting page. It is similar to what people do for their home router.

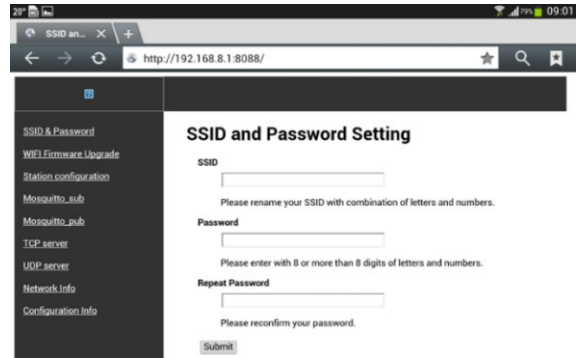

Type SSID name and password, repeat the same password, then press "Submit". The Wi-Fi SSID and password is changed and you need to re-connect the pump Wi-Fi with the new assigned SSID and Password. Scan QR code or type IP address 192.168.8.1 to access the web server page again.

## CONNECT TO HOME NETWORK

**(Caution)** User has to know how to do "Home Network Router" settings and it is preferred to do it by desktop or laptop PC. Refer to your router manual if necessary.



The NPVS variable speed pump Wi-Fi can be set to connect to Home Network to extend the control distance and easy access.

1. Type IP address 192.168.8.1:8 to access the Wi-Fi network setting. Select Station configuration.

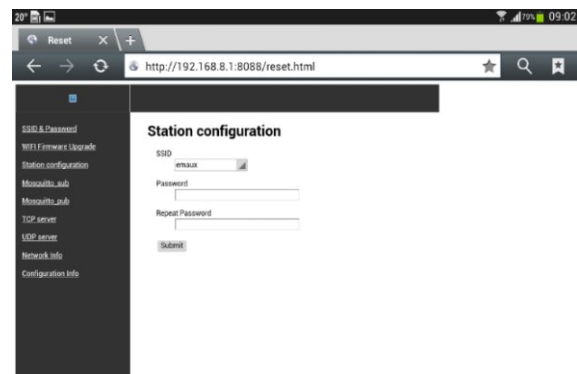

2. Type your Home Network SSID and password, repeat password and then press submit. It will show "success" when it is done. The NPVS will connect to Home Router automatically. The Direct-Wi-Fi connection SSID will be erased and can't be found and used again.
3. Access your router and go to DHCP Client list to find "EPV" new IP address. The location and display format will not be the same for different router band, so you must have the knowledge to get the new IP address from router from DHCP clients list.
4. Connect mobile phone / tablet to assigned Network, type the new assigned IP address on the web browser for user interface access.

ID	Client Name	MAC Address	Assigned IP	Lease Time
1	win8	F8-BC-12-9B-92-3F	192.168.0.100	01:59:24
2	EPV	14-CC-20-42-B8-E5	192.168.0.101	01:56:24
3	test-3-PC	16-CC-20-CE-14-93	192.168.0.102	01:54:42
4	iPhone-6	16-CC-20-D7-FD-E4	192.168.0.103	01:57:29

5. The same User Interface will be displayed and operation function remains the same.

## 8. Routine Maintenance

The only routine maintenance needed is inspection/cleaning of the pump basket/hair and lint pot. Debris or trash that collects in basket, will restrict the water flow through the pump. Follow instructions below to clean the basket:

- 1) Stop pump, close gate valve in suction and discharge, and release all pressure from system before proceeding.
- 2) Unscrew pump lid (turn anticlockwise).
- 3) Remove strainer basket and clean. Be sure all holes in basket are clear, rinse basket with water and replace in trap with large opening at pipe connection port (between ribs provided). If basket is replaced backwards, lid will not fit correctly.
- 4) Clean and inspect lid Ring; reinstall on trap cover.
- 5) Clean Ring groove on trap body and Replace lid. To help keep lid from sticking, tighten hand tight only.
- 6) Prime pump (see priming instructions in Section 1.2 on page 4).

## 9. Service & Repair Parts

Refer all service to your local agent or dealer as their knowledge of your equipment makes them the best qualified source of information.



## 10. Trouble Shooting

<p><b>MOTOR DOES NOT START</b></p> <ol style="list-style-type: none"> <li>1) Disconnect switch or circuit breaker in off position</li> <li>2) Fuses blown or thermal overload open</li> <li>3) Locked motor shaft</li> <li>4) Motor windings burned out</li> <li>5) Defective starting switch inside single phase motor</li> <li>6) Disconnected or defective wiring</li> <li>7) Low voltage</li> </ol>	<p><b>LOW PUMP CAPACITY</b></p> <ol style="list-style-type: none"> <li>1) Valve in suction or discharge line partly closed</li> <li>2) Suction or discharge line partly plugged</li> <li>3) Suction or discharge line too small</li> <li>4) Plugged basket in skimmer or hair and lint strainer</li> <li>5) Dirty filter</li> <li>6) Impeller clogged</li> </ol>
<p><b>PUMP DOES NOT REACH FULL SPEED</b></p> <ol style="list-style-type: none"> <li>1) Low voltage</li> <li>2) Pump connected for wrong voltage</li> </ol>	<p><b>HIGH PUMP PRESSURE</b></p> <ol style="list-style-type: none"> <li>1) Discharge valve or inlet fittings closed too much</li> <li>2) Return lines too small</li> <li>3) Dirty filters</li> <li>4) Incorrect speed setting</li> </ol>
<p><b>MOTOR OVERHEATS (protector trips)</b></p> <ol style="list-style-type: none"> <li>1) Low voltage</li> <li>2) Motor windings connected for wrong voltage on dual voltage model</li> <li>3) Inadequate ventilation</li> <li>4) Inadequate water flow</li> </ol>	<p><b>NOISY PUMP AND MOTOR</b></p> <ol style="list-style-type: none"> <li>1) Plugged basket in skimmer or hair in lint strainer</li> <li>2) Worn motor bearings</li> <li>3) Valve in suction line partly closed</li> <li>4) Suction line partly plugged</li> <li>5) Vacuum hose plugged or too small</li> <li>6) Pump not supported properly</li> </ol>
<p><b>PUMP DELIVERS NO WATER</b></p> <ol style="list-style-type: none"> <li>1) Pump is not primed</li> <li>2) Closed valve in suction or discharge line</li> <li>3) Leakage or air into suction system</li> <li>4) Impeller clogged</li> <li>5) Filter requires cleaning</li> </ol>	<p><b>AIR BUBBLES AT INLET FITTINGS</b></p> <ol style="list-style-type: none"> <li>1) Leakage of air into suction line at connections or valve stem</li> <li>2) Cover gasket of hair and lint strainer needs cleaning</li> <li>3) Low water level in pool</li> </ol>
<p><b>LEAKAGE OF WATER AT SHAFT</b></p> <ol style="list-style-type: none"> <li>1) Shaft seal requires replacement</li> </ol>	
<p><b>NOTE: If the recommendations in the trouble shooting portion of this manual do not solve your particular problem(s), please contact your local dealer or place of purchase for service.</b></p>	

## 11. Replacement Parts

### 11.1 Parts Diagram

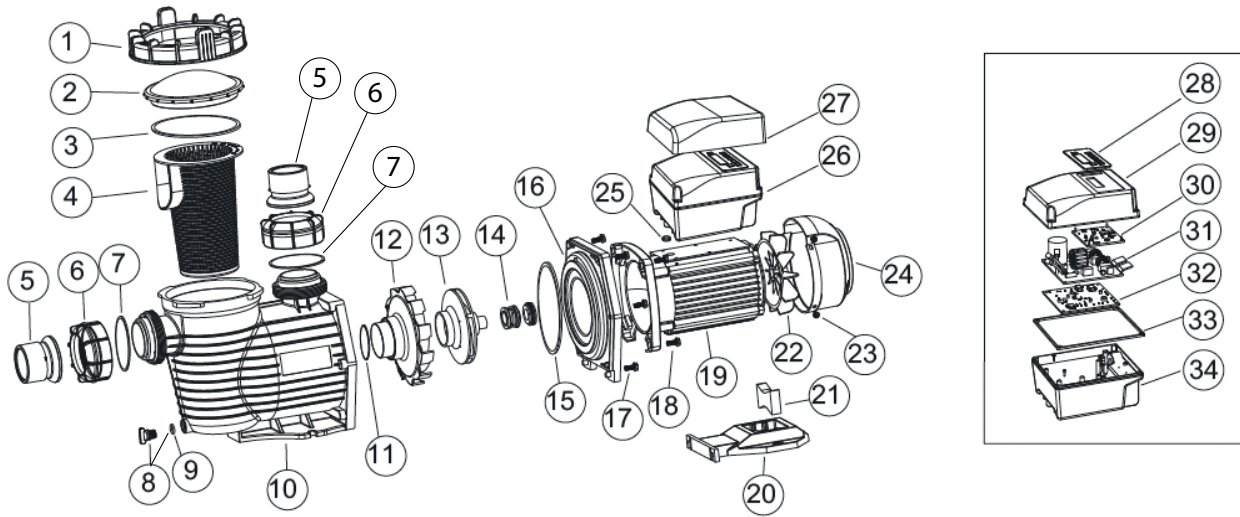

### 11.2 Parts Listing

Item NO.	Part NO.	Product Description	QTY
1, 2 & 3	NPP01	Pump Lid Assembly	1
1	NPP02	Lid Lock Ring	1
2	NPP04	Lid Clear Top	1
3	OR920	Lid O'Ring	1
4	SBN1	Basket	1
5	NPP06	Union Sleeve	1
6	NPP07	Union Nut	1
7	OR921	O-Ring Union	2
8	NPP10	Drain Plug & O-Ring	1
9	OR922	O-Ring Drain Plug	5
10	NPP09	Wet End	1
11	OR923	Diffuser O-Ring	4
12	NPP13	Diffuser	1
13	NPP15	Impeller for NPP750/NPVS150	1
14	MC16	3/4"Mechanical seal	1
15	OR924	Back Plate O-Ring	1
16	NPP20	Back Plate (Flange)	1
17	NPP21	Back Plate Bolts	6
18	NPP37	Motor Bolts	4
19	NPVS01	TYC-71L Motor	1
20	NPVS02	Motor Base	1
21	NPVS03	Motor Base Adaptor	1
22	NPVS04	Motor Cooling Fan	1
23	NPP34	Cooling Fan Cover Screws	4
24	NPVS06	Motor Cooling Fan Cover	1
25	NPVS07	Motor Cable Gasket	1
26	NPVS08	Programmable Controller for NPVS150	1
27	NPVS09	Transparent Lid for Programmable Controller	1
28	NPVS10	Touch Pad Overlay	1
29	NPVS11	Control Box Cover	1
30	NPVS12	operation panel (PCB)	1
31	NPVS13	PFC PCB	1
32	NPVS14	Driver PCB	1
33	NPVS15	Control Box Gasket	1
34	NPVS16	Control Box Bottom Case	1

## 12. Overall Dimensions

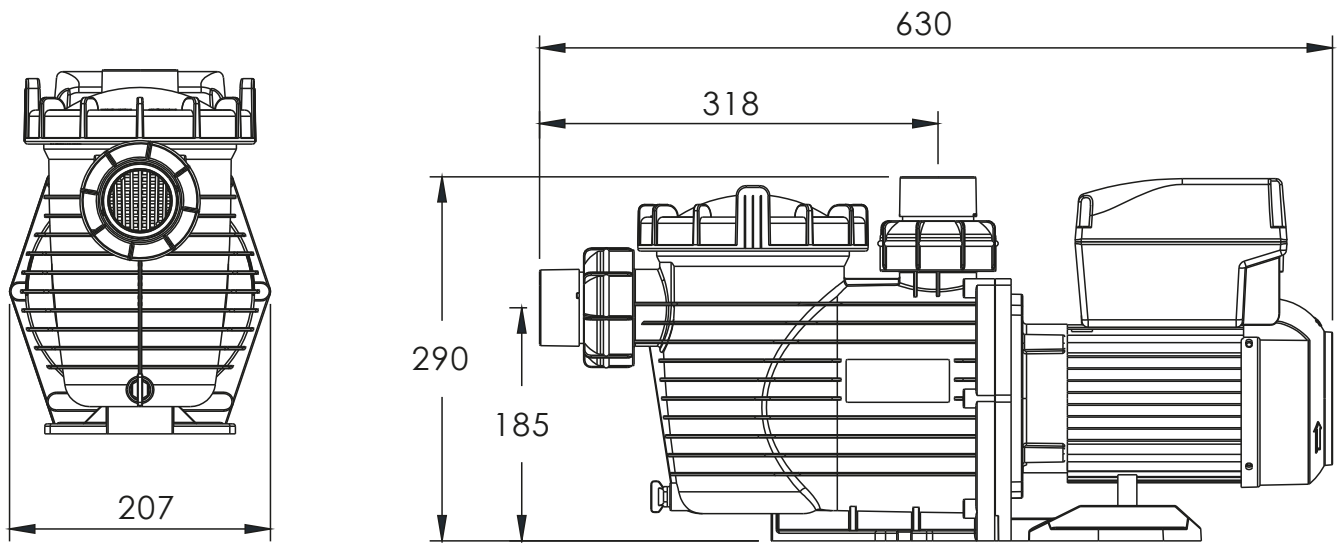

## 13. Product Information

Mode Code	Connection	Input Power	Horsepower	RPM
NPVS150	<b>Inlet:</b> 2" / 50mm <b>Outlet:</b> 1.5" / 40mm or 2" / 50mm	1.3kW	1.5hp	800-3400rpm